

# Clock Generator for PowerQUICC and PowerPC Microprocessors and Microcontrollers

**MPC9817**

The MPC9817 is a PLL-based clock generator specifically designed for Freescale Semiconductor Microprocessor and Microcontroller applications including the PowerPC and PowerQUICC. This device generates the microprocessor input clock and other microprocessor system and bus clocks at any one of four output frequencies. These frequencies include the popular 33- and 66-MHz PCI bus frequencies. The device offers five low-skew clock outputs plus three reference outputs. The clock input reference is 25 MHz and may be derived from an external source or by the addition of a 25-MHz crystal to the on-chip crystal oscillator. The extended temperature range of the MPC9817 supports telecommunication and networking requirements.

### Features

- 5 LVCMOS outputs for processor and other system circuitry
- 3 Buffered 25-MHz reference clock outputs
- Crystal oscillator or external reference input
- 25-MHz input reference frequency
- Selectable output frequencies include: 25, 33, 50, or 66 MHz
- Low cycle-to-cycle and period jitter
- Package: 20-lead SSOP
- 3.3-V supply
- Supports computing, networking, and telecommunications applications
- Ambient temperature range: -40°C to +85°C

### Functional Description

The MPC9817 uses a PLL with a 25-MHz input reference frequency to generate a single bank of five configurable LVCMOS output clocks. The output frequency of this bank is configurable to either 25, 33, 50, or 66 MHz by two FSEL pins. The 25-MHz reference may be either an external frequency source or a 25-MHz crystal. The 25-MHz crystal is directly connected to the XTAL\_IN and XTAL\_OUT pins with no additional components required. An external reference may be applied to the XTAL\_IN pin with the XTAL\_OUT pin left floating. The input reference, whether provided by a crystal or an external input, is also directly buffered to a second bank of three LVCMOS outputs. These outputs may be used as the clock source for processor I/O applications such as an Ethernet PHY. When FSEL0 and FSEL1 are both configured low, the QA outputs are directly fed from the input reference providing a total of eight low-skew 25-MHz outputs. For all other combinations of FSEL0 and FSEL1 the single-ended LVCMOS outputs provide five low-skew outputs for use in driving a microprocessor or microcontroller clock input as well as other system components.

The MPC9817 is packaged in a 20-lead SSOP package.

### MICROPROCESSOR CLOCK GENERATOR

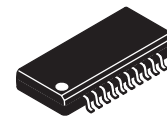

**SD SUFFIX  
20 SSOP PACKAGE  
CASE 1461-01**

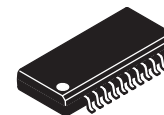

**EN SUFFIX  
20 SSOP PACKAGE  
Pb-FREE PACKAGE  
CASE 1461-01**

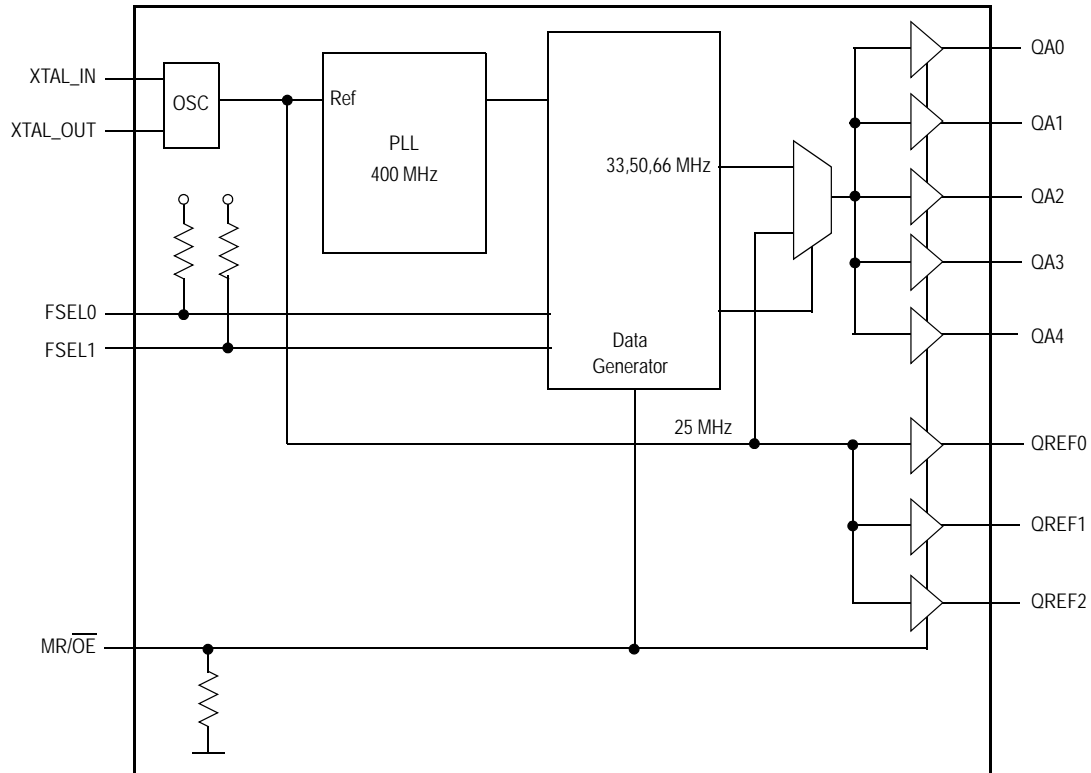

Figure 1. MPC9817 Logic Diagram

Table 1. Pin Configurations

Pin	I/O	Type	Function
QA0, QA1, QA2, QA3, QA4	Output	LVC MOS	Clock Outputs
QREF0, QREF1, QREF2	Output	LVC MOS	Reference Output (25 MHz)
XTAL_IN	Input	LVC MOS	Crystal Oscillator Input Pin
XTAL_OUT	Output	LVC MOS	Crystal Oscillator Output Pin
FSEL0, FSEL1	Input	LVC MOS	Configures Bank A Clock Output Frequency (pull-up)
MR/OE	Input	LVC MOS	Enables All Outputs (pull-down)
V <sub>DD</sub>	—	—	3.3-V Supply
GND	—	—	Ground

Table 2. Function Table

Control	Default	00	01	10	11
FSEL0, FSEL1	11	25 MHz fed directly from reference input, PLL disabled	33 MHz	50 MHz	66 MHz

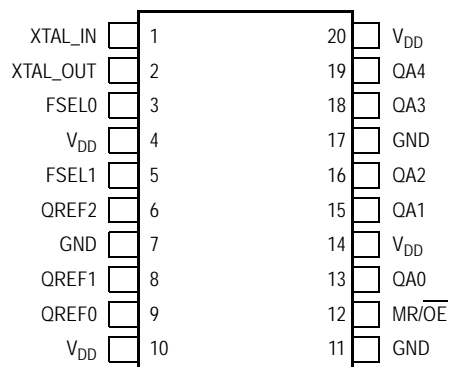

Figure 2. MPC9817 20-Lead SSOP Package Pinout (Top View)

### MPC9817 OPERATION

#### Crystal Oscillator

The MPC9817 features a fully integrated Pierce oscillator to minimize system implementation costs. Other than the addition of a 25-MHz crystal, no external components are required. The crystal selection should be: 25 MHz, parallel resonant type with a load specification of  $C_L = 10$  pF. Crystals with a load specification of  $C_L = 20$  pF may be used, however,

the reference frequency may be higher than the specified 25 MHz. Externally supplied capacitors on both the XTAL\_IN and XTAL\_OUT pins may be used to trim the frequency as desired.

The crystal should be located as close to the MPC9817 XTAL\_IN and XTAL\_OUT pins as possible to avoid any board level parasitic.

Table 3. Crystal Specifications

Parameter	Value
Crystal Cut	Fundamental AT Cut
Resonance	Parallel Resonance
Shunt Capacitance ( $C_L$ )	5–7 pF
Load Capacitance ( $C_O$ )	10 pF
Equivalent Series Resistance (ESR)	20–60 $\Omega$

#### Power Supply Bypassing

The MPC9817 should have all  $V_{DD}$  pins bypassed with 0.01 capacitors and a minimum of one 1.0 capacitor for the overall package. All capacitors should be located as close to the SSOP pins as possible.

#### External Clock Source

An external reference source of 25 MHz may be applied to the XTAL\_IN pin. In this mode of operation, the XTAL\_OUT pin should be left floating.

**Table 4. Absolute Maximum Ratings<sup>(1)</sup>**

Symbol	Characteristics	Min	Max	Unit	Condition
V <sub>DD</sub>	Supply Voltage	-0.3	3.8	V	
I <sub>IN</sub>	DC Input Current	—	±20	mA	
I <sub>OUT</sub>	DC Output Current	—	±75	mA	
T <sub>S</sub>	Storage Temperature	-65	125	°C	

1. Absolute maximum continuous ratings are those maximum values beyond which damage to the device may occur. Exposure to these conditions or conditions beyond those indicated may adversely affect device reliability. Functional operation at absolute-maximum-rated conditions is not implied.

**Table 5. General Specifications**

Symbol	Characteristics	Min	Typ	Max	Unit	Condition
V <sub>TT</sub>	Output Termination Voltage	—	V <sub>DD</sub> ÷ 2	—	V	
MM	ESD Protection (machine model)	200	—	—	V	
HBM	ESD Protection (human body model)	2000	—	—	V	
LU	Latch-Up Immunity	200	—	—	mA	
C <sub>IN</sub>	Input Capacitance	—	4	—	pF	Inputs
θ <sub>JA</sub>	Thermal Resistance (junction-to-ambient)	—	80.8	—	°C/W	
T <sub>C</sub>	Ambient Temperature	-40	—	85	°C	

**Table 6. DC Characteristics** (V<sub>DD</sub> = 3.3 V ± 5%, T<sub>A</sub> = -40° to +85°C)

Symbol	Characteristics	Min	Typ	Max	Unit	Condition
V <sub>IH</sub>	Input High Voltage (XTAL_IN)	2.4	—	V <sub>DD</sub> + 0.3	V	Input threshold = V <sub>DD</sub> /2
V <sub>IH</sub>	Input High Voltage	2.0	—	V <sub>DD</sub> + 0.3	V	
V <sub>IL</sub>	Input Low Voltage	—	—	0.8	V	LVC MOS
I <sub>IN</sub>	Input Current <sup>(1)</sup>	—	—	150	μA	V <sub>IN</sub> = V <sub>DDL</sub> or GND
V <sub>OH</sub>	Output High Voltage	2.4	—	—	V	I <sub>OH</sub> = -12 mA
V <sub>OL</sub>	Output Low Voltage	—	—	0.4	V	I <sub>OL</sub> = 12 mA
Z <sub>OUT</sub>	Output Impedance	—	14	—	Ω	
I <sub>DD</sub>	Maximum Quiescent Supply Current	—	8.0	15.0	mA	V <sub>DD</sub> pins

1. Inputs have pull-down resistors affecting the input current.

**Table 7. AC Characteristics<sup>(1) (2)</sup>** ( $V_{DD} = 3.3 \text{ V} \pm 5\%$ ,  $T_A = -40^\circ$  to  $+85^\circ\text{C}$ )

Symbol	Characteristics	Min	Typ	Max	Unit	Condition
Input and Output Timing Specification						
$f_{ref}$	Input Reference Frequency	25 MHz Input XTAL Input	25 25		MHz MHz	
$f_{VCO}$	VCO Frequency Range	—	400	—	MHz	
$f_{MCX}$	Output Frequency (QAx)	FSEL0, FSEL1 = 00	25	—	MHz	PLL locked
		FSEL0, FSEL1 = 01	33	—	MHz	
		FSEL0, FSEL1 = 10	50	—	MHz	
		FSEL0, FSEL1 = 11	66	—	MHz	
	Output Frequency (QREFx)	25	—	MHz		
$f_{refPW}$	Reference Input Pulse Width	10	—	—	ns	@ 25 MHz
DC	Output Duty Cycle	47.5	50	52.5	%	
$f_{out}$	Output Frequency Accuracy	Crystal <sup>(3)</sup>	—	100	ppm	With recommended crystal see Table 3
		External Reference	—	0	ppm	
PLL Specifications						
BW	PLL Closed Loop Bandwidth <sup>(4)</sup>		500		kHz	
$t_{LOCK}$	Maximum PLL Lock Time			10	ms	
Skew and Jitter Specifications						
$t_{sk(O)}$	Output-to-Output Skew (within a bank)			100	ps	
$t_{sk(O)}$	Output-to-Output Skew (between bank A and bank Ref)			200		FSEL0, FSEL1 = 00
$t_{JIT(CC)}$	Cycle-to-Cycle Jitter			150	ps	@ 25 MHz Input Reference Q <sub>A</sub> output
$t_{JIT(PER)}$	Period Jitter			100	ps	@ 25 MHz Input Reference Q <sub>A</sub> output
$t_r, t_f$	Output Rise/Fall Time			1	ns	20% to 80%

1. AC characteristics are design targets and pending characterization.
2. AC characteristics apply for parallel output termination of  $50 \Omega$  to  $V_{TT}$ .
3. Based upon recommended crystal specifications as outlined in operation section.
4.  $-3$  dB point of PLL transfer characteristics.

**Figure 3. MPC9817 AC Test Reference (LVCMOS Outputs)**

Table 8. MPC9817 Pin List

Pin	Description	Pin	Description
1	XTAL_IN	11	GND
2	XTAL_OUT	12	MR/OE
3	FSEL0	13	QA0
4	V <sub>DD</sub>	14	V <sub>DD</sub>
5	FSEL1	15	QA1
6	QREF2	16	QA2
7	GND	17	GND
8	QREF1	18	QA3
9	QREF0	19	QA4
10	V <sub>DD</sub>	20	V <sub>DD</sub>

PACKAGE DIMENSIONS

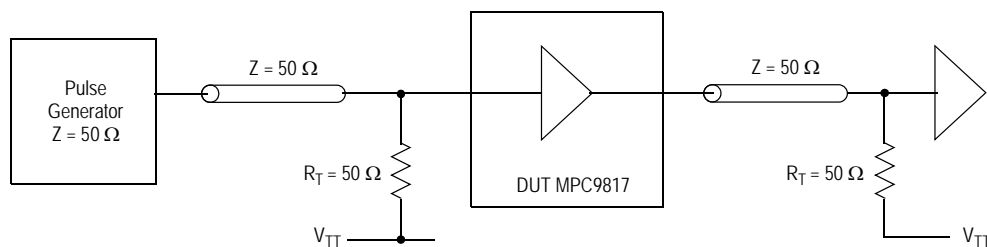
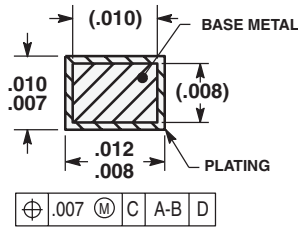
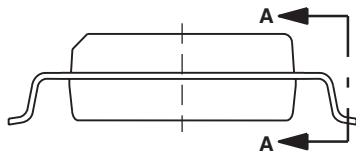
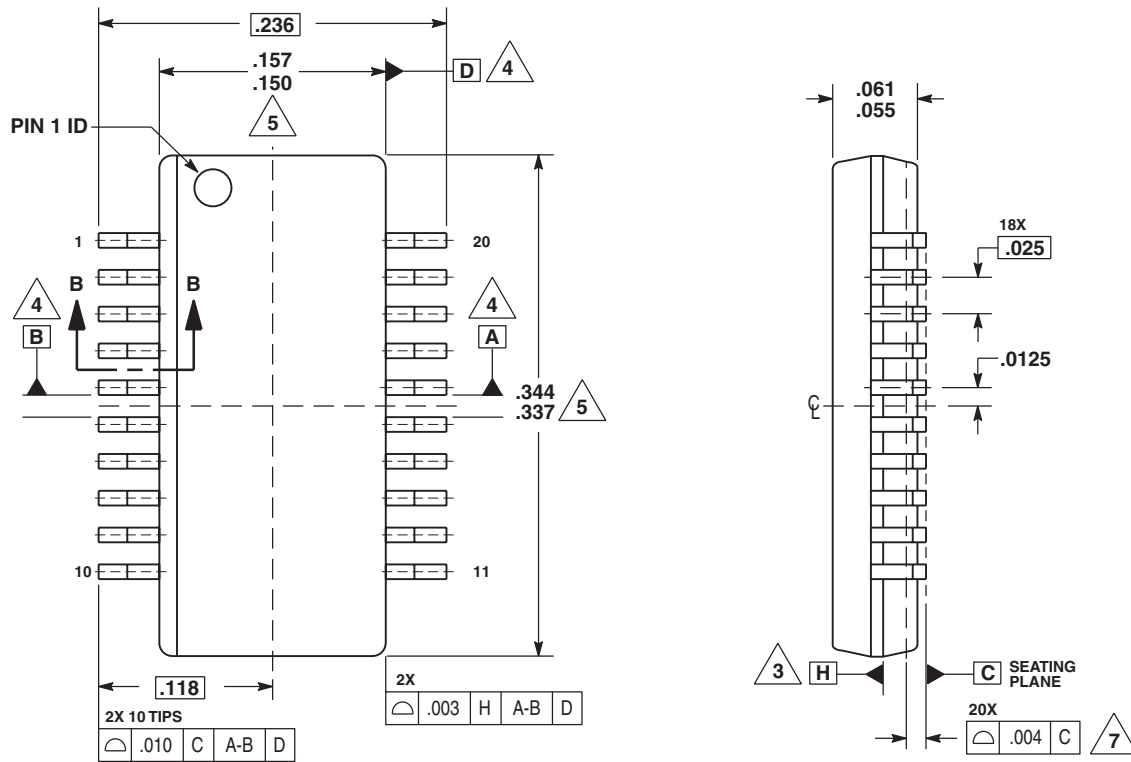

SECTION A-A

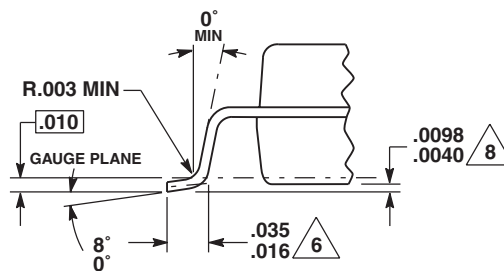

SECTION B-B

NOTES:

1. DIMENSIONS ARE IN INCHES.
2. DIMENSIONING AND TOLERANCING PER ASME Y14.5M, 1994.
3. DATUM PLANE H LOCATED AT MOLD PARTING LINE AND COINCIDENT WITH LEAD, WHERE LEAD EXITS PLASTIC BODY AT BOTTOM OF PARTING LINE.
4. DATUM A, B AND D TO BE DETERMINED WHERE CENTERLINE BETWEEN LEADS EXITS PLASTIC BODY AT DATUM PLANE H.
5. THIS DIMENSION DOES NOT INCLUDE MOLD FLASH OR PROTRUSIONS, BUT DO INCLUDE MOLD MISMATCH AND ARE MEASURED AT THE MOLD PARTING LINE. MOLD FLASH OR PROTRUSIONS SHALL NOT EXCEED .006 INCHES FOR ENDS AND .008 INCHES FOR SIDES.
6. THIS DIMENSION IS LENGTH OF TERMINAL FOR SOLDERING A SUBSTRATE.
7. FORMED LEADS SHALL BE PLANAR WITH RESPECT TO ONE ANOTHER WITHIN .004 INCHES AT SEATING PLANE.
8. THIS DIMENSION IS DEFINED AS THE DISTANCE FROM THE SEATING PLANE TO THE LOWEST POINT OF THE PACKAGE BODY.

CASE 1461-02  
ISSUE O  
20 SSOP PACKAGE

Innovate with IDT and accelerate your future networks. Contact:

**www.IDT.com**

**For Sales**

800-345-7015  
408-284-8200  
Fax: 408-284-2775

**For Tech Support**

netcom@idt.com  
480-763-2056

---

**Corporate Headquarters**

Integrated Device Technology, Inc.  
6024 Silver Creek Valley Road  
San Jose, CA 95138  
United States  
800 345 7015  
+408 284 8200 (outside U.S.)

**Asia Pacific and Japan**

Integrated Device Technology  
Singapore (1997) Pte. Ltd.  
Reg. No. 199707558G  
435 Orchard Road  
#20-03 Wisma Atria  
Singapore 238877  
+65 6 887 5505

**Europe**

IDT Europe, Limited  
Prime House  
Barnett Wood Lane  
Leatherhead, Surrey  
United Kingdom KT22 7DE  
+44 1372 363 339